

规格/TECHNICAL SPECIFICATIONS

型号/MODEL NUMBER:	I LENS770-R5050-90T-4H1-NH
透镜尺寸/LENS DIMENSIONS:	49.5*49.5*7.37MM
定位方式/FASTENING:	锁螺丝、定位柱/Screw or Pin
是否符合ROHS/ROHS COMPLIANT:	是/YES

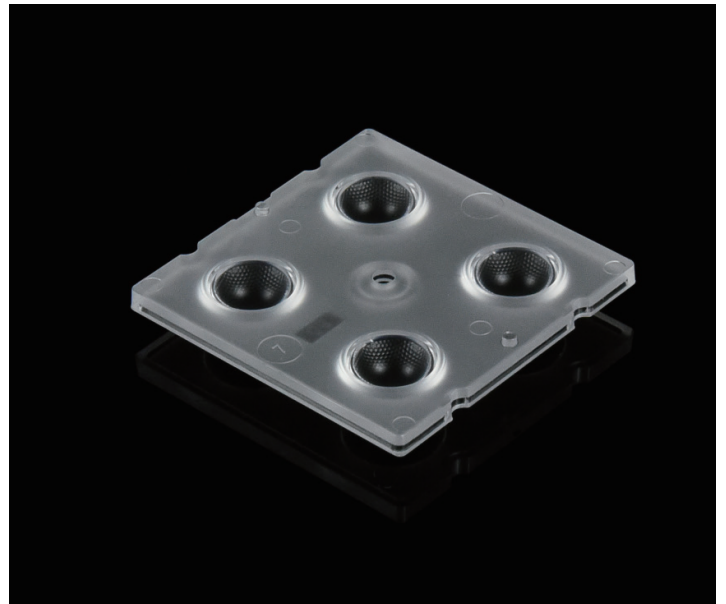

说明/CHARACTERISTIC:

1. 多种不同配光角度的镜片。
A variety of lenses with different light distribution angles.
2. 一体化镜头无支架。
The integrated lens has no bracket.
3. 兼容多种灯珠。
Compatible with various lamp beads.
4. 适用于洗墙灯、投光灯。
Suitable for wall washer, flood light.
5. I LENS229升级, 光效更好, 光斑更漂亮, 兼容性更好。
I LENS229 upgrade, better light effect, more beautiful spot and better compatibility.

LED:CREE XPG3
 角度/FWHM:97°
 光效/Efficiency:88%
 峰值强度/Peakintensity:0.44CD/LM
 光学面数量/LED/each optic:4
 灯光颜色/Light colour:白色/White
 所需组件/Required components:

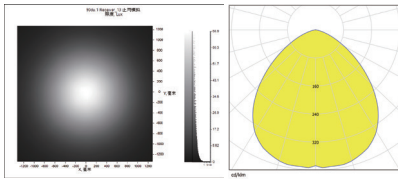

LED:CREE XML3
 角度/FWHM:91°
 光效/Efficiency:88%
 峰值强度/Peakintensity:0.49CD/LM
 光学面数量/LED/each optic:4
 灯光颜色/Light colour:白色/White
 所需组件/Required components:

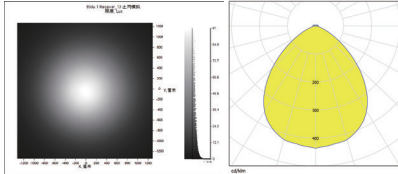

LED:CREE XPL2
 角度/FWHM:95°
 光效/Efficiency:88%
 峰值强度/Peakintensity:0.46CD/LM
 光学面数量/LED/each optic:4
 灯光颜色/Light colour:白色/White
 所需组件/Required components:

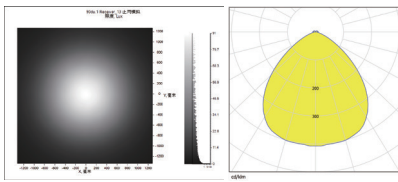

LED:LUXEON 4*3030 2D
 角度/FWHM:83°
 光效/Efficiency:88%
 峰值强度/Peakintensity:0.57CD/LM
 光学面数量/LED/each optic:4
 灯光颜色/Light colour:白色/White
 所需组件/Required components:

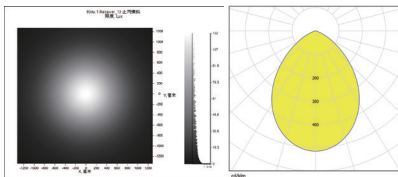

LED:LUXEON 5050
 角度/FWHM:85°
 光效/Efficiency:88%
 峰值强度/Peakintensity:0.56CD/LM
 光学面数量/LED/each optic:4
 灯光颜色/Light colour:白色/White
 所需组件/Required components:

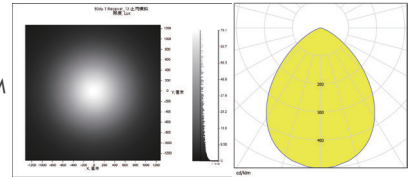

LED:SAMSUNG LH351B
 角度/FWHM:91°
 光效/Efficiency:88%
 峰值强度/Peakintensity:0.51CD/LM
 光学面数量/LED/each optic:4
 灯光颜色/Light colour:白色/White
 所需组件/Required components:

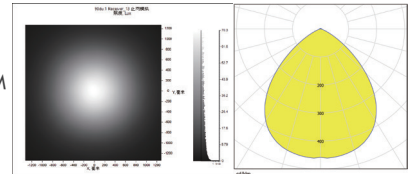

LED:SAMSUNG 4*2835
 角度/FWHM:82°
 光效/Efficiency:88%
 峰值强度/Peakintensity:0.59CD/LM
 光学面数量/LED/each optic:4
 灯光颜色/Light colour:白色/White
 所需组件/Required components:

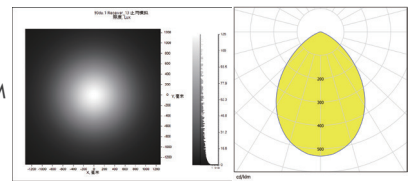

LED:OSRAM 3737
 角度/FWHM:87°
 光效/Efficiency:88%
 峰值强度/Peakintensity:0.52CD/LM
 光学面数量/LED/each optic:4
 灯光颜色/Light colour:白色/White
 所需组件/Required components:

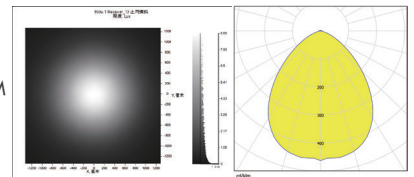

LED:CREE XPG3
 角度/FWHM:99°
 光效/Efficiency:94%
 峰值强度/Peakintensity:0.42CD/LM
 光学面数量/LED/each optic:4
 灯光颜色/Light colour:白色/White
 所需组件/Required components:

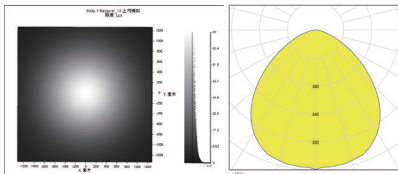

LED:CREE XML3
 角度/FWHM:95°
 光效/Efficiency:94%
 峰值强度/Peakintensity:0.46CD/LM
 光学面数量/LED/each optic:4
 灯光颜色/Light colour:白色/White
 所需组件/Required components:

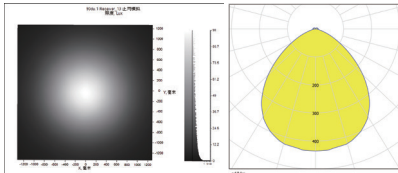

LED:CREE XPL2
 角度/FWHM:98°
 光效/Efficiency:94%
 峰值强度/Peakintensity:0.43CD/LM
 光学面数量/LED/each optic:4
 灯光颜色/Light colour:白色/White
 所需组件/Required components:

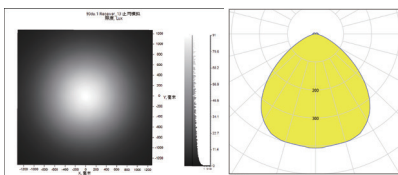

LED:LUXEON 4*3030 2D
 角度/FWHM:86°
 光效/Efficiency:94%
 峰值强度/Peakintensity:0.53CD/LM
 光学面数量/LED/each optic:4
 灯光颜色/Light colour:白色/White
 所需组件/Required components:

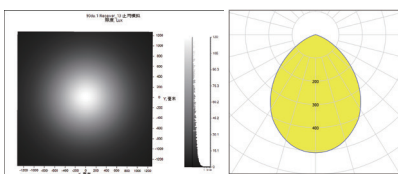

LED:LUXEON 5050
 角度/FWHM:88°
 光效/Efficiency:94%
 峰值强度/Peakintensity:0.52CD/LM
 光学面数量/LED/each optic:4
 灯光颜色/Light colour:白色/White
 所需组件/Required components:

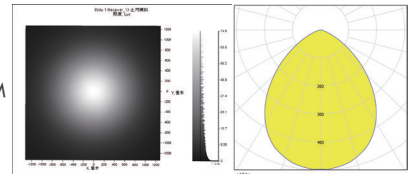

LED:SAMSUNG LH351B
 角度/FWHM:95°
 光效/Efficiency:94%
 峰值强度/Peakintensity:0.48CD/LM
 光学面数量/LED/each optic:4
 灯光颜色/Light colour:白色/White
 所需组件/Required components:

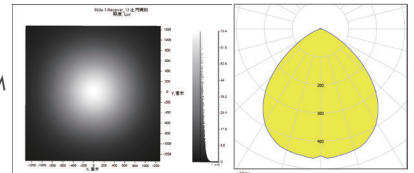

LED:SAMSUNG 4*2835
 角度/FWHM:85°
 光效/Efficiency:94%
 峰值强度/Peakintensity:0.55CD/LM
 光学面数量/LED/each optic:4
 灯光颜色/Light colour:白色/White
 所需组件/Required components:

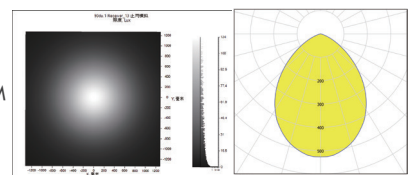

LED:OSRAM 3737
 角度/FWHM:91°
 光效/Efficiency:94%
 峰值强度/Peakintensity:0.48CD/LM
 光学面数量/LED/each optic:4
 灯光颜色/Light colour:白色/White
 所需组件/Required components:

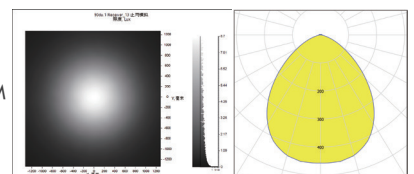

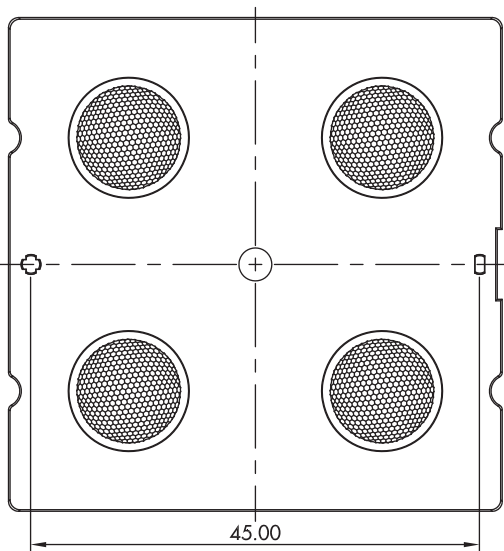
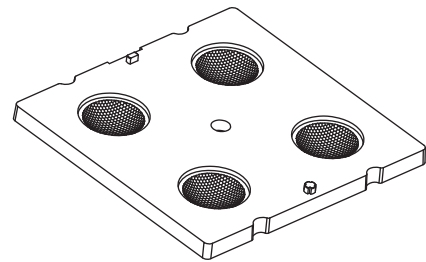
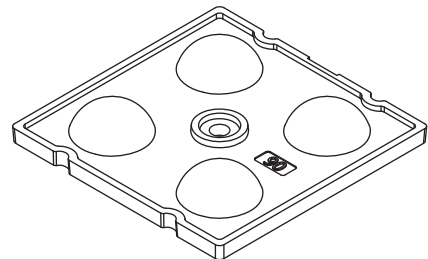
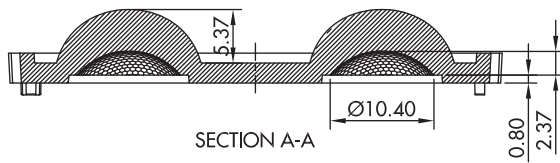
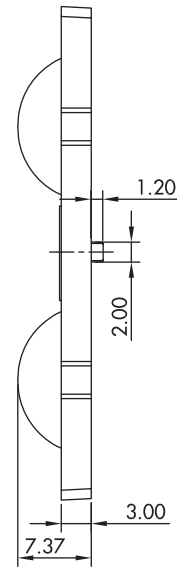
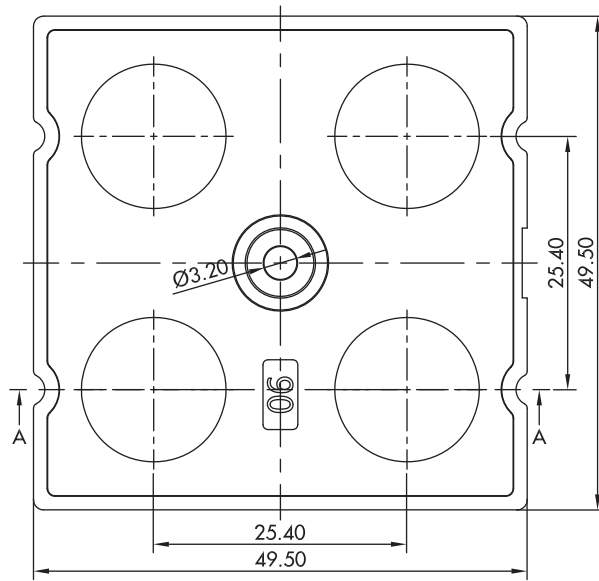

注意/NOTE:

1. 镜片表面应光滑无划痕、气泡、凹痕和黑点。

The surface of the lens should be smooth without scratches, bubbles, dents and black spots.

GENERAL TOLERANCES ISO2768-M (UNLESS STATED) 一般公差ISO 2768-M (除非另有说明)	MATERIAL 材质	PMMA or PC	DRAWING TITLE 绘图标题	I LENS770-R5050-90T-4H1-NH
LINEAR/线性	0~5±0.05		5~10±0.1	10~30±0.15
ANGULAR/角度	0°~10°±1°		10°~50°±0.5°	50°~120°±0.3°

产品包装/PRODUCTS PACKAGING

型号	数量
ILENS770-R5050-90T-4H1-NH	1000pcs
吸塑Blister -A(B)-310*240*20	50pcs
外盒Cardboard -485*315*385	1pcs

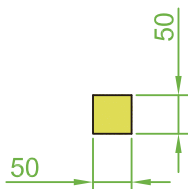

ILENS770-R5050-XX-4H1-NH

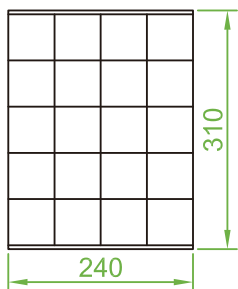

吸塑Blister-A(B)-310*240*20

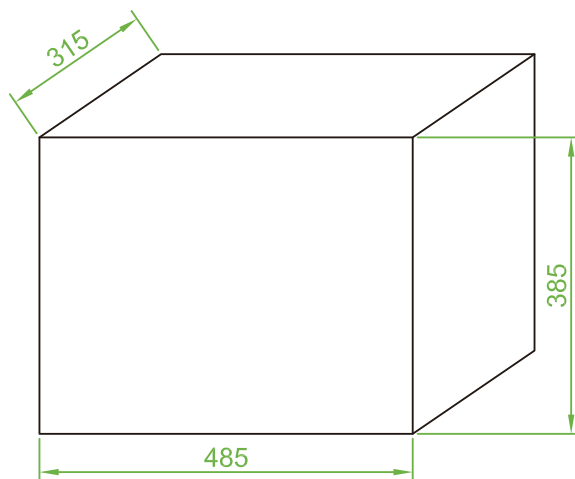

外盒Cardboard -485*315*385

示意图/The schematic diagram:

