

规格/TECHNICAL SPECIFICATIONS

型号/MODEL NUMBER:	I LENS916-S10-M20-NH
透镜尺寸/LENS DIMENSIONS:	Φ10.0*7.0MM
定位方式/FASTENING:	定位柱/Pin
是否符合ROHS/ROHS COMPLIANT:	是/YES

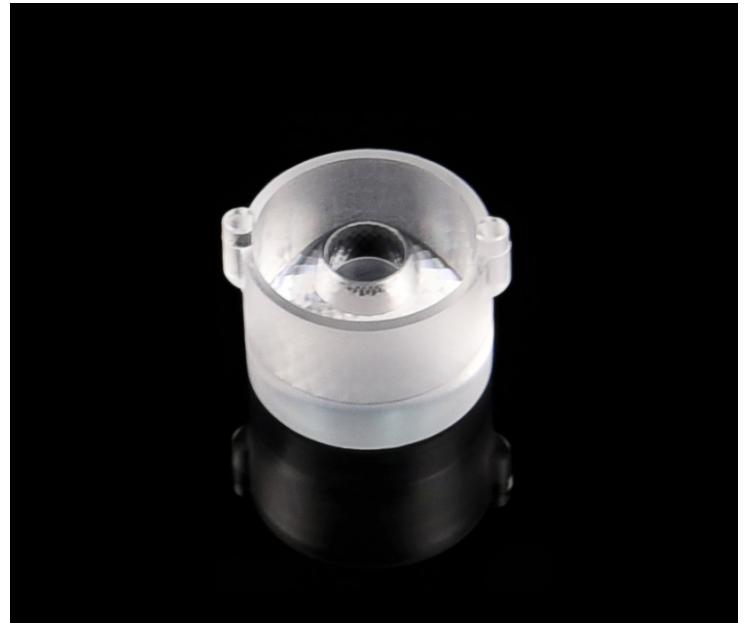

说明/CHARACTERISTIC:

1. 透镜有多种不同的配光角度。
The lens have multiple types beam angles .
2. 一体防水透镜，定位柱定位安装。
Waterproof lens. use pins for fix.
3. 兼容多种灯珠。
Compatible with various lamp beads.
4. 适用于洗墙灯和投光灯。
Suitable for wall washing lighting and floodlights.
5. 与市面上同类镜头相比，光效更好，光斑更漂亮，兼容性更好。
Compared with similar type lenses on the market,with better light effect ,more beautiful spot and better compatibility.

LED:CREE XPE2
 角度/FWHM:18°
 光效/Efficiency:88%
 峰值强度/Peakintensity:5.9CD/LM
 光学面数量/LED/each optic:1
 灯光颜色/Light colour:白色/White
 所需组件/Required components:

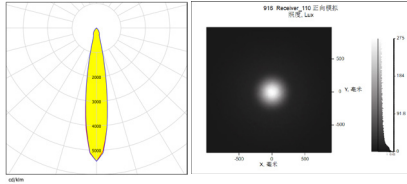

LED:CREE XPG2
 角度/FWHM:24°
 光效/Efficiency:88%
 峰值强度/Peakintensity:3.9CD/LM
 光学面数量/LED/each optic:1
 灯光颜色/Light colour:白色/White
 所需组件/Required components:

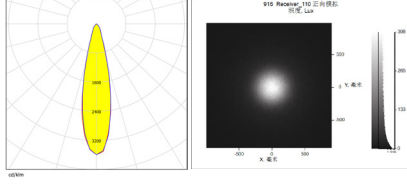

LED:CREE XBD
 角度/FWHM:22°
 光效/Efficiency:88%
 峰值强度/Peakintensity:4.8CD/LM
 光学面数量/LED/each optic:1
 灯光颜色/Light colour:白色/White
 所需组件/Required components:

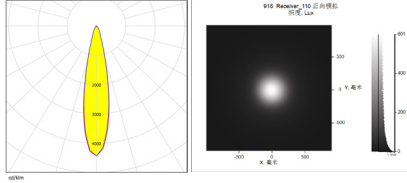

LED:LG 3535
 角度/FWHM:26°
 光效/Efficiency:88%
 峰值强度/Peakintensity:3CD/LM
 光学面数量/LED/each optic:1
 灯光颜色/Light colour:白色/White
 所需组件/Required components:

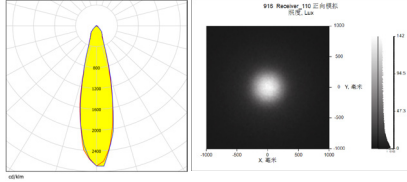

LED:LUMILEDS HL2X
 角度/FWHM:27°
 光效/Efficiency:88%
 峰值强度/Peakintensity:2.8CD/LM
 光学面数量/LED/each optic:1
 灯光颜色/Light colour:白色/White
 所需组件/Required components:

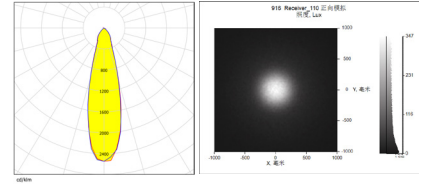

LED:LUMILEDS 3030
 角度/FWHM:21°
 光效/Efficiency:88%
 峰值强度/Peakintensity:4.5CD/LM
 光学面数量/LED/each optic:1
 灯光颜色/Light colour:白色/White
 所需组件/Required components:

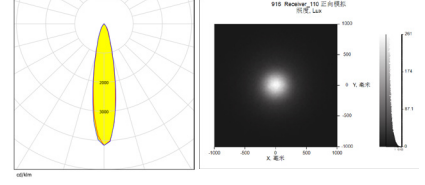

LED:OSRAM P3030
 角度/FWHM:18°
 光效/Efficiency:88%
 峰值强度/Peakintensity:5.8CD/LM
 光学面数量/LED/each optic:1
 灯光颜色/Light colour:白色/White
 所需组件/Required components:

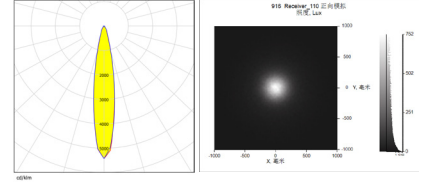

LED:SEOUL SZ5
 角度/FWHM:29°
 光效/Efficiency:88%
 峰值强度/Peakintensity:2CD/LM
 光学面数量/LED/each optic:1
 灯光颜色/Light colour:白色/White
 所需组件/Required components:

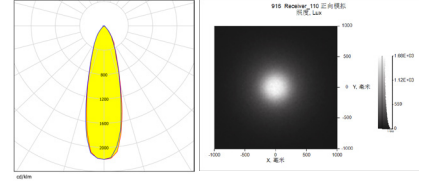

CAD

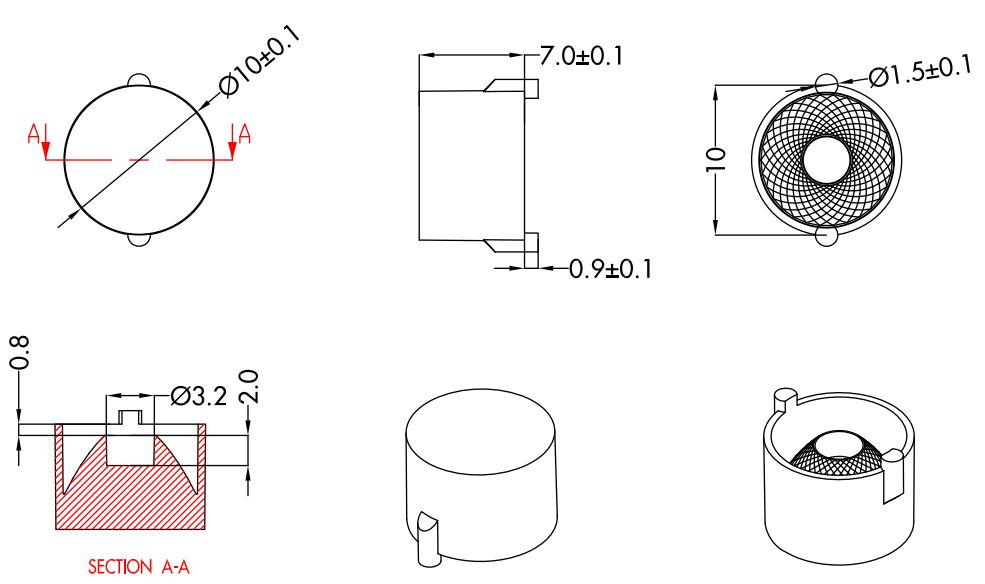

注意/NOTE:

1. 镜片表面应光滑无划痕、气泡、凹痕和黑点。

The surface of the lens should be smooth without scratches, bubbles, dents and black spots.

GENERAL TOL ERANCES ISO2768-M (UNLESS STATED) 一般公差ISO 2768-M (除非另有说明)	MATERIL 材质	PC	DRAWING TITLE 绘图标题	I LENS916-S10-M20-NH
LINEAR/线性	0~5±0.05		5~10±0.1	10~30±0.15
ANGULAR/角度	0°~10°±1°		10°~50°±0.5°	50°~120°±0.3°

产品包装/Products Packaging

型号/Part No.	数量/QTY
IENS916-S10-M20-NH	36000pcs
内盒/cardboard box (S)	18pcs
外盒/cardboard box (M)	1pcs



2000pcs

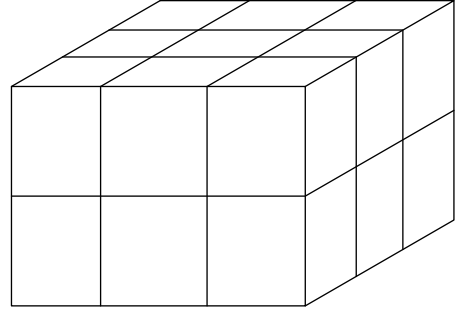
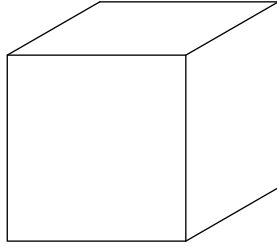

2000pcs*18=36000pcs